

Lilly

---

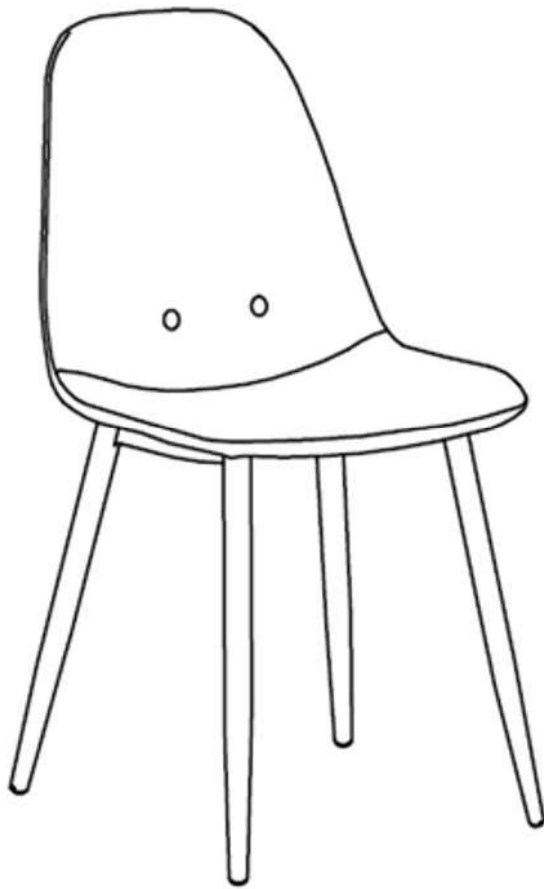

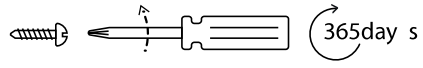

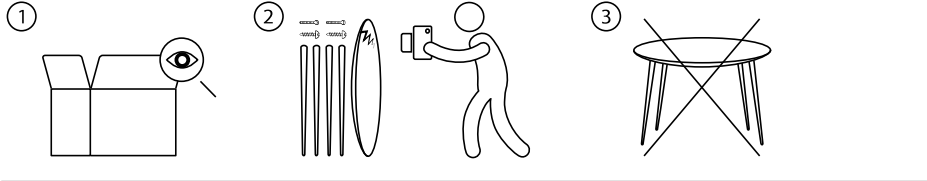
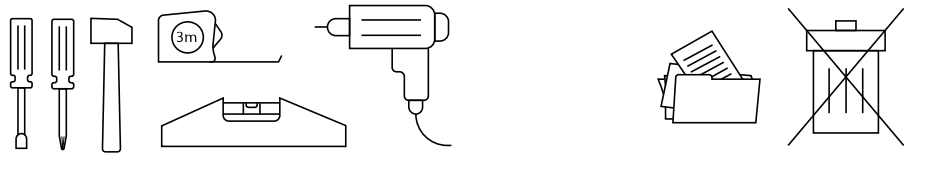

10 min

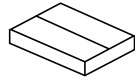

x1



x1

---



D x1



E x1

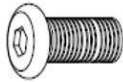

A x4 (M6x16)



B x4 (Ø6)



C x1 #5

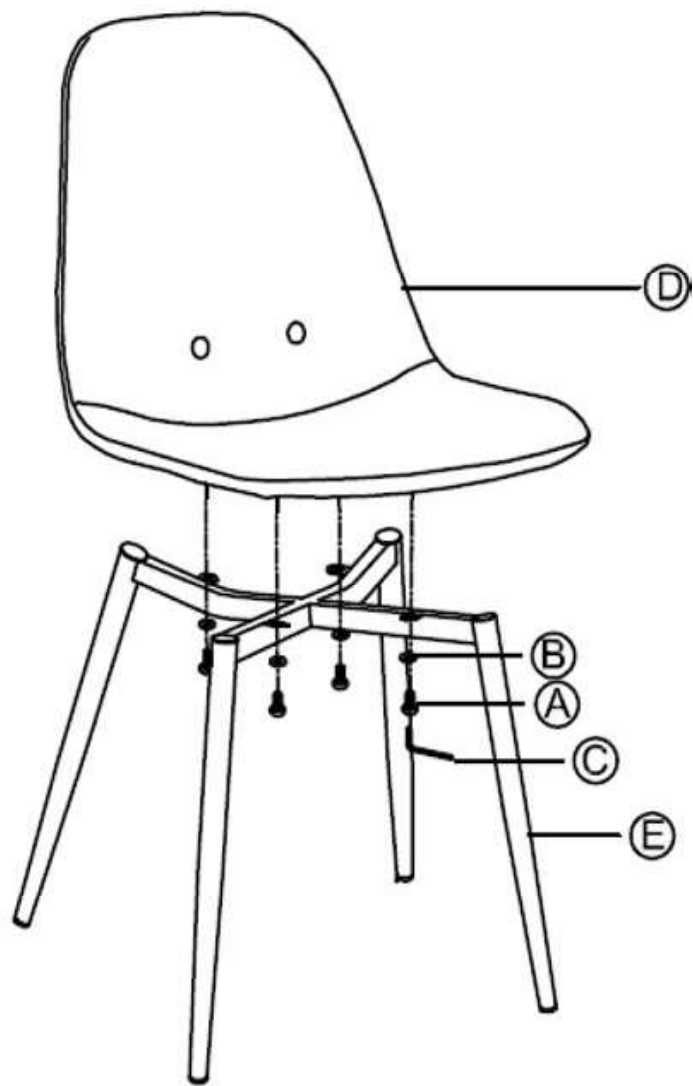

1

